

# Slim Deep Series

Low glare index with super visual comfort !

Slim Deep 6W



Slim Deep 12W



With clips as ceiling light or deck light or With mounting sleeve as inground light

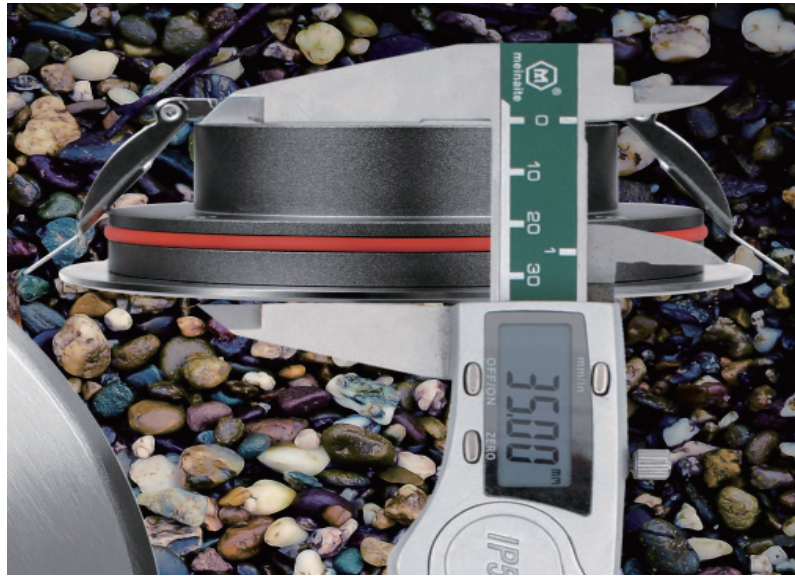

Ultra slim 35mm height  
IP67 waterproof

# Slim Deep 6W



With mounting sleeve as inground light

Anti-glare  
 UGR<5 when 15°  
 UGR<11 when 24°  
 UGR < 20 when 40°

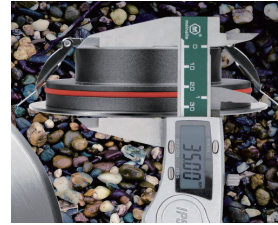

Ultra slim 35mm height

With clips as ceiling light or deck light



Anti-glare uplight in corridor



Waterproof downlight



outdoor uplight where with limited depth

Dimension .....

Light Distribution Curve (3000K,40°) .....

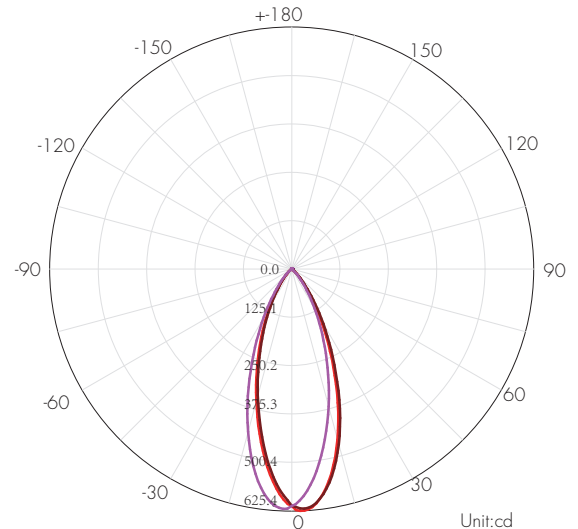
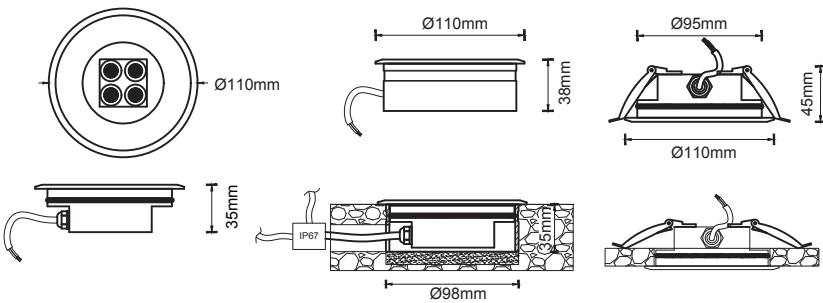

CE RoHS COMPLIANT IP67 IK08

SSS 316 3 Years Warranty

Unit:cd

Parameter .....

**General Data**

Item No.	UL-4001-0600-E
Power	6W +10%
LED type	4 PCS 1.5W OSRAM 3030 LED
Luminous flux	500 lm +10%
CCT	2700K, 3000K, 4000K, 6000K
CRI	80+
Beam angle	15°, 24°, 40°
Dimension	Φ110x35 (mm) Diameter x length
Cut out	Φ98 mm with sleeve, Φ95mm with clip
Net weight	0.58 kgs
Warranty	3 years
Certifications	CE, RoHS

**Electrical Data**

Input voltage	DC24V
Insulation class	Class III
Cable	1PC rubber cable 1M HO5RN-F 2x1mm square
Driver	low voltage constant voltage input , constant current output for LED

**Construction Data**

IP rating	IP67 Waterproof
IK rating	IK08
Housing	Passivated(Anodizing) Aluminum
Protection finishing	20~25µm thickness anodized film for housing. Dark grey
Trim	Stainless steel 316
Glass	Step tempered Glass, T=8mm.
Loading capacity	500 kgs
Cable Gland	PG gland
Gasket	PMQ silicone seal

**Accessories**

Mounting Sleeve	Passivated (Anodizing) Aluminum. Dark grey
-----------------	--

**Packaging**

Inner box size	120*120*60 mm
Carton size	38.5*26.5*20.5 cm (18 PCS/carton)

**Features** .....

- . Anti-glare optics design with UGR<5 @15°, UGR<11 @24°, UGR<20 @40° , super visual comfort !
- . Ideal for the application of places where are with limited depth that can only be installed with the ultra slim inground light, such as corridor of hotel, outdoor ground uplight.
- . With clip optional for application of outdoor slim deck light , outdoor Slim downlight on the roof, waterproof downlight in the bathroom etc..
- . No screws on the trim for beautiful appearance
- . Excellent design of heat-conducting housing ensure long life time of LED
- . Aluminum housing CNC machined
- . 20~25µm thickness of anti-corrosion protective passivated film for housing.
- . Waterproof IP67.
- . OSRAM 3030 LED with LM80 approval.
- . 3 years warranty.
- . Structure silicone seal+ glue seal for IP67.
- . Professional sales and technicians to serve you.

**Installation Drawing** .....

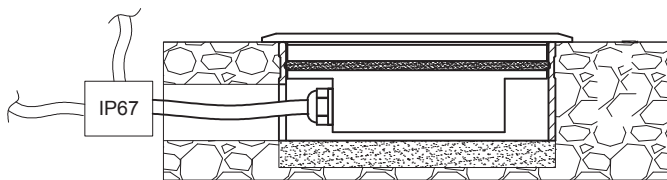

**With mounting sleeve as inground light**

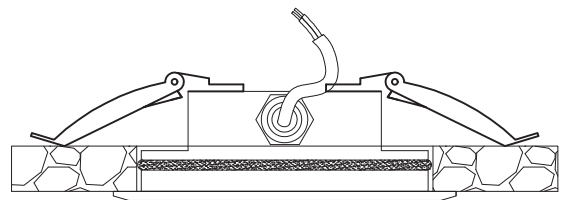

**With clips as ceiling light or deck light**



**Lux distance Curve (3000K,40°)** .....

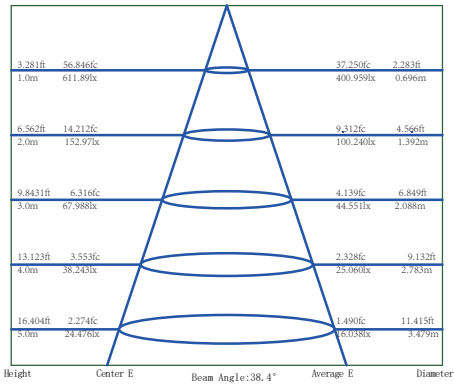

**Illumination Picture (40°)** .....

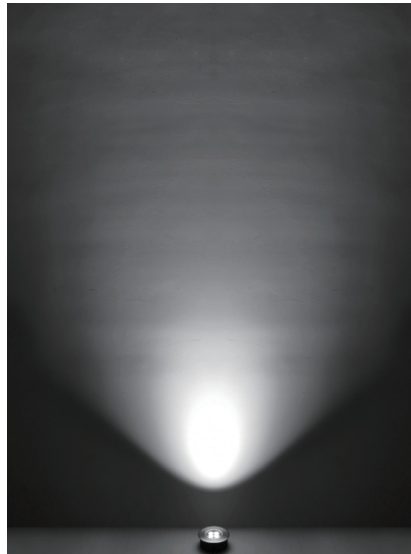



# Slim Deep 12W



With mounting sleeve as inground light

Anti-glare  
 UGR<5 when 15°  
 UGR<11 when 24°  
 UGR < 20 when 40°

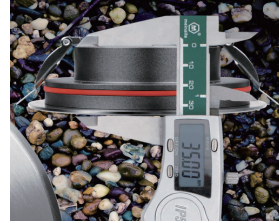

Ultra slim 35mm height

With clips as ceiling light or deck light



Plaza illumination where the anti-glare is necessary



Outdoor downlight



outdoor uplight where with limited depth

Dimension .....

Light Distribution Curve (3000K,24°) .....

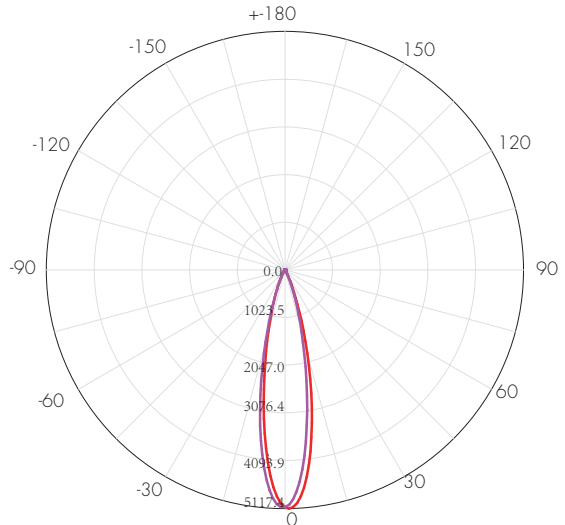
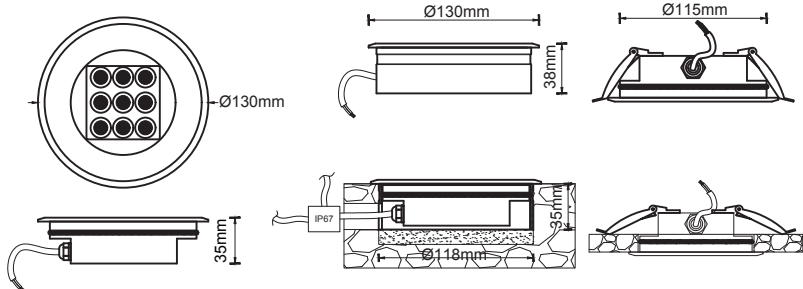

CE RoHS COMPLIANT IP67 IK08

SSS 316 3 Years Warranty

Parameter .....

**General Data**

Item No.	UL9001-1200-E
Power	12W +10%
LED type	9 PCS 1.3V OSRAM 3030 LED
Luminous flux	1000 lm +10%
CCT	2700K, 3000K, 4000K, 6000K
CRI	80+
Beam angle	15°, 24°, 40°
Dimension	Φ130x35 (mm) Diameter x length
Cut out	Φ118 mm with sleeve, Φ115mm with clip
Net weight	0.75 kgs
Warranty	3 years
Certifications	CE, RoHS

**Electrical Data**

Input voltage	DC24V
Insulation class	Class III
Cable	1PC rubber cable 1M HO5RN-F 2x1mm square
Driver	low voltage constant voltage input , constant current output for LED

**Construction Data**

IP rating	IP67 Waterproof
IK rating	IK08
Housing	Passivated(Anodizing) Aluminum
Protection finishing	20~25µm thickness anodized film for housing. Dark grey
Trim	Stainless steel 316
Glass	Step tempered Glass, T=8mm.
Loading capacity	500 kgs
Cable Gland	PG gland
Gasket	PMQ silicone seal

**Accessories**

Mounting Sleeve	Passivated (Anodizing) Aluminum. Dark grey
-----------------	--

**Packaging**

Inner box size	140*140*60 mm
Carton size	30.5*30.5*20.5 cm (12 PCS/carton)

**Features** .....

- Anti-glare optics design with UGR<5 @15°, UGR<11 @24°, UGR<20 @40° , super visual comfort !
- Ideal for the application of places where are with limited depth that can only be installed with the ultra slim inground light, such as corridor of hotel, outdoor ground uplight.
- With clip optional for application of outdoor slim deck light , outdoor Slim downlight on the roof, waterproof downlight in the bathroom etc..
- No screws on the trim for beautiful appearance
- Excellent design of heat-conducting housing ensure long life time of LED
- Aluminum housing CNC machined
- 20~25µm thickness of anti-corrosion protective passivated film for housing.
- Waterproof IP67.
- OSRAM 3030 LED with LM80 approval.
- 3 years warranty.
- Structure silicone seal+ glue seal for IP67.
- Professional sales and technicians to serve you.

**Installation Drawing** .....

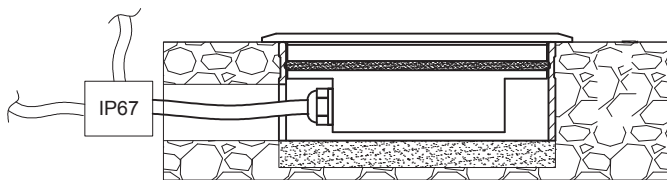

**With mounting sleeve as inground light**

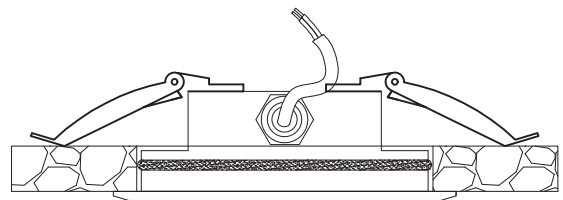

**With clips as ceiling light or deck light**



**Lux distance Curve (3000K,24°)** .....

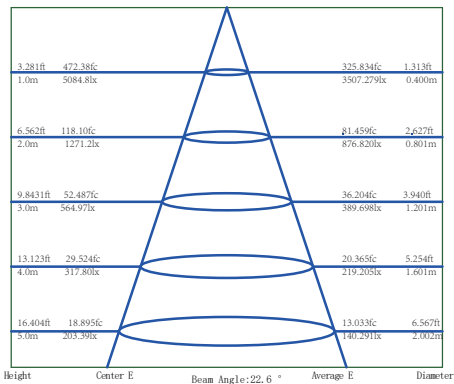

**Illumination Picture (24°)** .....

